

**BALCONIES** FOR ALL ETERNITY.



**werzalit**<sup>®</sup>  
LASTING. BEAUTY.

FOR EVER, AND FOR EVERY LOCATION. **WERZALIT.**





Whether a new build or a redevelopment, whether in the Black Forest or in Death Valley – Werzalit measures up to all demands for a modern construction material, in terms of its economics, its design capabilities, and naturally its durability and longevity. Because our fascias, balconies, and window boards show themselves to best advantage even after decades anywhere in the world, and even in extreme climate regions.

# WOOD ON THE INSIDE, TOUGH ON THE OUTSIDE. WERZALIT-



For nearly half a century, Werzalit has been defying all weathers and all challenges. It all began with the idea of forming a naturally-grown product, wood. That idea has developed into a patented process under which finely chipped wood in a precisely measured mix is pressed into desired shape using heat and pressure. The result is a derived wood product which remains unique to this day – Werzalit.

# DERIVED TIMBER PRODUCT.



But it is not just its highly compacted and homogenous structure which makes Werzalit so unique. Precisely-formulated recipes and the special surface finish ensure its exceptional qualities. The non-detachable bond between the materials of the core and the surface is at the heart of these permanently robust products. They are extremely resistant to heat, cold and mechanical stress. The choice of materials used also contributes to the legendary quality of Werzalit products. We use only selected healthy wood from sustainably managed forests, to create an adaptable material which lasts and can be used in all situations.

# WITH WERZALIT, EVERY BALCONY GAINS A DISTINCTIVE



## Example: Sectional profile F 170

Sectional profile with softened finish on edges. 170 mm width, in standard lengths up to 5,500 mm. For laying vertically, horizontally or on the diagonal. Can be supplied optionally with an integral window box cover, to match all Werzalit claddings.



## Example: Cladding panel

For closed face balcony cladding. In standard formats up to 3,650 mm width, and available in 65 different colour finishes and 8 decorative wood treatments.

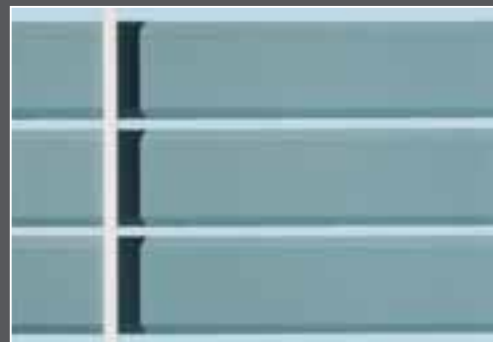

## Example: Sectional profile F 230

Sectional profile. Finish as for F 170, except 230 mm width. Suitable for laying in any direction, as it can be cut to individual lengths of up to 5,500 mm.



Werzalit balcony profiles are design elements for houses and fascias and provide screening from view, for a sense of privacy even when you are out in the open. The modular construction principle opens up a wealth of different cladding options. The S and F range profiles, for example, are suitable for arranging vertically, horizontally, diagonally or in contrasting directions, thanks to their ability to be cut to individual lengths. A total of eight installation-ready moulded profiles are available, in graduated attachment lengths and widths, and there is also a range of cladding panels in a variety of sizes for closed face cladding solutions.

# PROFILE.



## Example: "Allgäu" moulded profile

Installation-ready moulded profile. For balcony cladding in a typical country look. Available in 71 new colours.

## Example: Sectional profile S145

Sectional profile, 145 mm width, with straight line moulding. For balcony cladding arranged vertically, horizontally or even diagonally. Alternatively available as S85 and S205, with 85 mm or 205 mm width.

## Balcony sectional profile S

Standard length = 5,500 mm

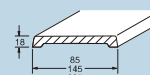

## F

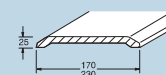

## Balcony moulded profiles

### Spessart

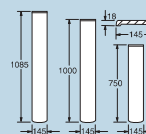

### Harz

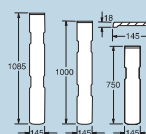

### Taunus

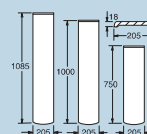

### Röhn

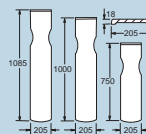

### Stuttgart

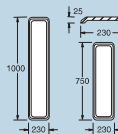

### Allgäu

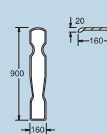

### Eifel

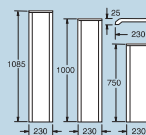

### Rügen

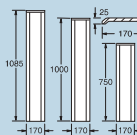

## Coloured cladding panels

Formats	
2,180 x 1,020 x 6	2,180 x 1,020 x 8
3,050 x 1,320 x 6	3,050 x 1,320 x 8
3,650 x 1,320 x 6	3,650 x 1,320 x 8
Other formats on request	

## Hand-rail options for 125 railing system

### Standard



### Rondo 2



all measurements in mm

# THE INTERPLAY OF COLOURS.

Friedrich Ernst von Garnier – a name synonymous with the interplay of colours.

For the virtuoso harmony of red and green tones, or the staging of graduations of yellow and blue.

Worlds of colour are created which complement one another perfectly. And it was the hand of Friedrich Ernst von Garnier which lay behind the creation of the new Colorpan colour collection. With graduations of colour from pastel tones through to strong statements, and with 71 colour nuances conveying warmth or coolness – it is a collection which positively invites the creative urge.

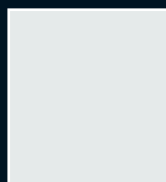

601

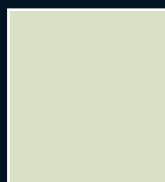

606



616



602



607



612



617



622



603



608



613



618



623



609

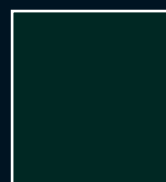

614



624



610



615



625

# THE NEW COLORPAN COLOUR COLLECTION.



626

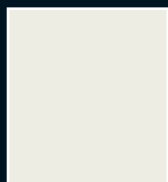

636

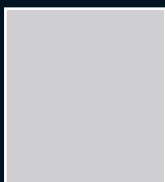

651



666



627

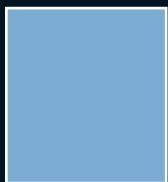

632



637



642



652



657



662



667



628



633



638



643

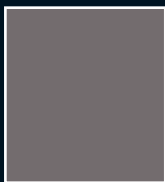

653



658



663



668



629



634



639

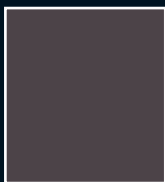

654

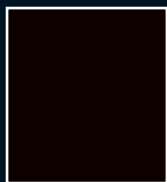

659

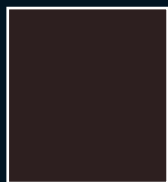

664



669



630



635

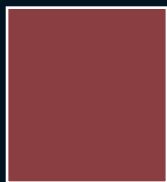

660



665

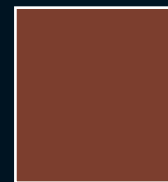

670

Colours may deviate from those of the originals due to the technicalities of printing!



671

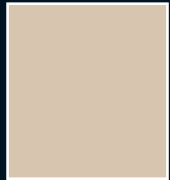

676



681



691



672



677



682



687



692



673



678



683



688



693

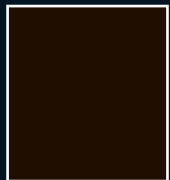

679

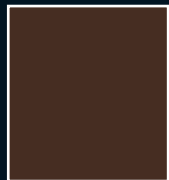

684



689



680



685



690



235

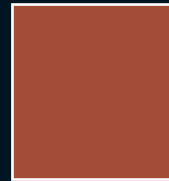

209



040

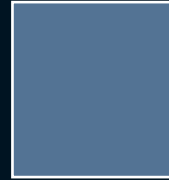

210



041



211



042



212



043

# WERZALIT CLADDING PANELS.



510

514



511

515



512

516



513

517

# THE NEW COLOURS – WHOLLY CONTEMPORARY.



Colours may deviate from those of the originals due to the technicalities of printing!



552



565



570



592



597



553

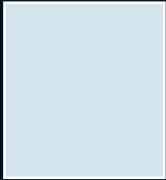

557



561



566



571



593



598



554



558



562



567



572



594



599



555

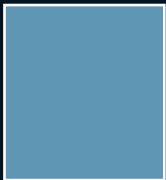

559



563



568



573



595



556

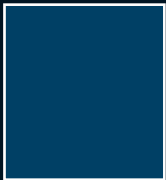

560



564



569



574



596

EVERY LOOK STANDS FOR **FREEDOM IN DESIGN.**



As with any material, with Werzalit too it all comes down to what you do with it. Werzalit offers the freedom to express individual ideas. From the variety of colours and forms through to integrated window-box covers as a decorative design element. It makes no difference whether it is a new build, a redevelopment or modernising work – since Werzalit claddings can be installed effortlessly onto pre-existing sub-constructions or can be installed as a complete system, including type-tested railings and a hand-rail to produce that harmonious visual finish.



WERZALIT IS **UNIQUE THREE TIMES OVER**: WATER-RESISTANT,

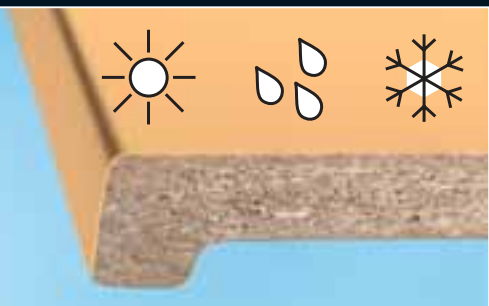

# EASY TO MAINTAIN, RESISTANT



Whether exposed to extremes of heat, strong UV radiation, permanent humidity or grating cold – Werzalit balcony profiles and panels are colour-true, are guaranteed not to blister, retain the form of their shape, and are therefore an investment which repays the commitment involved. For decades. Year on year.

# FACTS TO GRAB HOLD OF ABOUT OUR RAILING SYSTEMS.

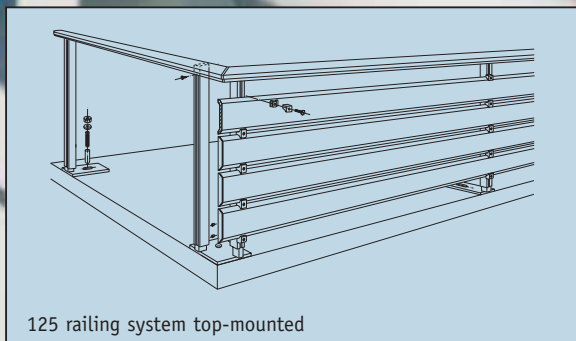

125 railing system top-mounted

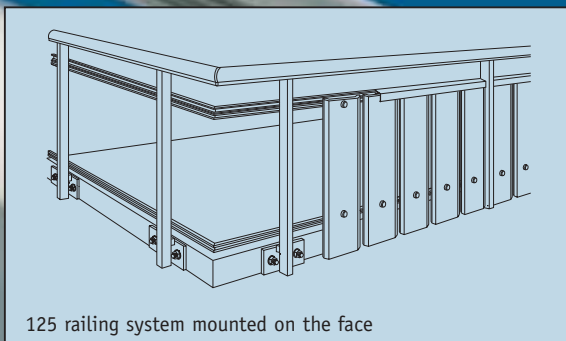

125 railing system mounted on the face

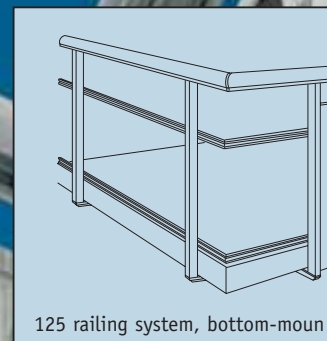

125 railing system, bottom-moun

You can rely on the type-tested aluminium railing system even before it is installed: our technical customer services department will advise you which system is best suited to your needs. Thanks to the wide range of accessories, installation is both quick and safe, irrespective of whether it is to be mounted as a projecting fitting or attached to either the top or the bottom of the flooring. With Werzalit railing systems, in a matter of moments you know you are on the safe side. That holds equally true in terms of its visual appearance: because the design of every set of railings is matched to the range of profiles.

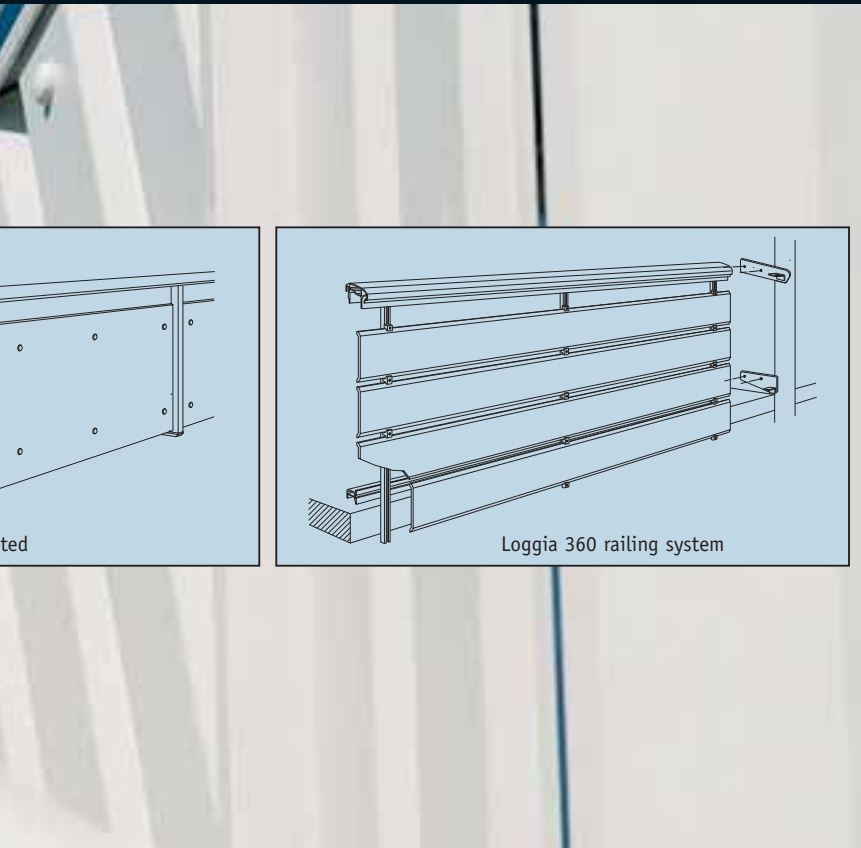

The top-mounted 125 railing system. Suitable for balcony claddings with both visible and concealed edges to the balcony. For new builds and untreated balcony floors, where the final floor covering is applied afterwards.

The face-mounted 125 railing system. Ideal for balcony claddings with a concealed balcony edge. For new builds and modernisations of existing floor coverings.

The bottom-mounted 125 railing system, with adjustable alignment of support pillars. Especially suitable for redevelopments of existing balconies.

Loggia 360 railing system. For open-span railing systems of up to 3,600 mm between two loggia walls, without placing the load onto the floor panel. Can also be supplied as system 600 for widths up to 5,950 mm.

Technical alterations reserved.

# ADVICE, DECISION-MAKING, PLANNING: THE WERZALIT FULL-

Our free service offer can assist you in the choice and planning of your individual Werzalit balcony, and serves as the basis for a detailed estimate of costs. Simply select the desired balcony type and colour nuance, specify the construction details using the checklist and submit the information by fax or post. Our technical customer services department will contact you as quickly as possible with the estimated costing for your project.

You can also get further information via the Internet, at [www.werzalit.de](http://www.werzalit.de), where you can find out everything you need to know about the various possibilities for using weather-resistant Werzalit materials.

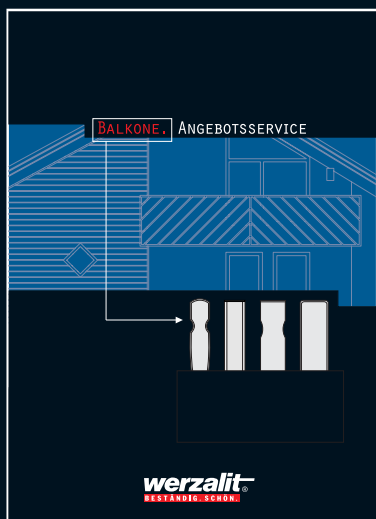

[www.werzalit.de](http://www.werzalit.de) • Phone: +49 (0) 70 62/50-0

# SERVICE OFFER FOR BALCONIES.

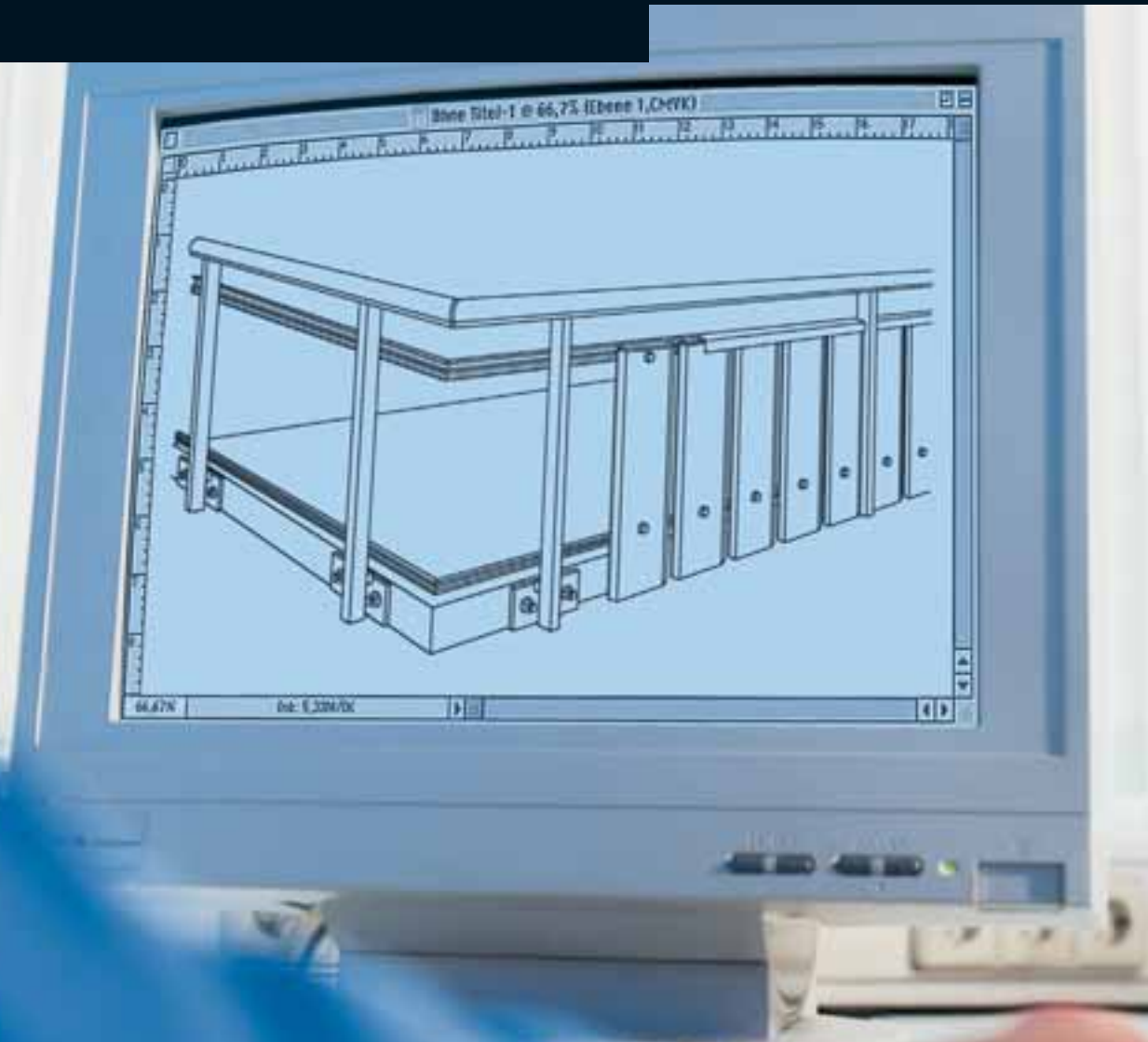

**werzalit®**  
**LASTING. BEAUTY.**

Werzalit AG + Co. KG  
Postfach 20 · D-71718 Oberstenfeld  
Germany  
Phone +49 (0) 70 62/50-0  
Fax +49 (0) 70 62/50 208  
[www.werzalit.de](http://www.werzalit.de)

